

# ZAXIS 350



## HYDRAULIC EXCAVATOR

Model Code : ZX350-5B / ZX360LC-5B / ZX350H-5B / ZX360LCH-5B

Engine Rated Power : 202 kW

Operating Weight : ZX350-5B : 32 600 - 33 800 kg

ZX360LC-5B : 33 300 - 34 500 kg

ZX350H-5B : 34 600 - 35 400 kg

ZX360LCH-5B : 35 300 - 36 100 kg

Backhoe Bucket ISO Heaped : 1.15 - 1.86 m<sup>3</sup>



# WALK AROUND

## CONTENTS

### 4-5 Performance

Enhanced power, torque and speed ensure the optimum performance of every Hitachi machine.

### 6-7 Productivity

The new ZAXIS have a high impact on efficiency but a low impact on the environment.

### 8-9 Comfort

The cab of the new ZAXIS provides a safer and comfortable work space.

### 10-11 Durability

Hitachi is renowned for manufacturing high-quality machines that can meet the demands of the toughest job sites.

### 12-13 Maintenance

Easily accessible features for cleaning and routine maintenance maximise the availability of the ZAXIS 350.

### 14-15 Hitachi Support Chain

A wide range of after-sales services and support options is available to all our customers.

### 16-24 Specifications

#### Lower fuel costs

The TRIAS hydraulic system reaches higher yields with better fuel consumption than the previous ZAXIS model.

#### Added durability

The strengthened brackets on the boom end and foot are equipped with bushings to withstand rugged environments.

#### Faster movement

The arm recirculation cancel and hydraulic boosting systems increase the arm speed during operation.

#### Enhanced versatility

Two additional spools in the control valve allow for the easy installation of attachments.



**ZAXIS** Empower your Vision.

The design of the new Hitachi ZAXIS 350 medium excavator is inspired by one aim – empower your vision. It delivers on five key levels: performance, productivity, comfort, durability and reliability. We recognise that fleet owners require high-quality, efficient machines that can work effectively, even in challenging conditions. We also realise that operators need a safer, user-friendly work space, and a machine that can respond to their skills with speed and precision. And to achieve a satisfying result, on time, on budget and to a high standard, we have aimed to maximise availability of the new ZAXIS 350 with easy maintenance features and the Hitachi Support Chain after-sales programme.

### **Expanded leg room**

The seat and console can slide further back on the new ZAXIS, providing a more comfortable working environment for the operator. The right side console has been ergonomically re-designed.

### **Ultimate comfort**

The heated air suspension seat is ideal in cold climates and absorbs vibration during operation minimising operator fatigue.

### **Easily accessible information**

The large multi-function LCD monitor screen is easy to view in bright sunlight or darkness and provides technical data.

### **Quick and easy service access**

The air conditioning condenser can be easily opened for cleaning the condenser and radiator. Inspection parts are conveniently located.



*NOTE : The photo in this brochure show excavators with optional equipment.*



# PERFORMANCE

The all-new ZAXIS 350 medium excavator provides the ultimate in performance. Our engineers have assessed the machine's every component to ensure that it always carries out its tasks to the highest standard. Benefiting from enhanced power, torque and speed, as well as reduced running costs, you can be assured that the ZAXIS 350 is the ideal choice for any earth-moving or construction project.



# Enhanced power and speed set a new standard on the job site



## Lower fuel costs

Winning tenders and meeting production targets are highly competitive processes for you to develop your business. The choice of construction machinery is of paramount importance and your success relies on the productivity and efficiency of your equipment. This is where our new TRIAS hydraulic system comes into its own.

The latest advanced hydraulic and electronic technologies are central to our goal of delivering a significant saving on fuel costs with the new low-emission engine. We are delighted that TRIAS hydraulics allow you to achieve 5% less fuel consumption in PWR mode – than the previous ZAXIS P-mode – while maintaining a high level of productivity at the same time\*.

Furthermore, a reduction of 15% in fuel consumption is also possible in ECO mode\*. This still delivers a relatively high level of productivity using the same amount of fuel.

## Higher level of performance

A smooth, fast and precise machine is every operator's dream – and that's exactly what the ZAXIS 350 offers. Our latest innovations have been developed specifically for the new generation of Hitachi medium excavators.

The hydraulic boosting system and other hydraulic systems enable the arm roll-in speed to increase when the load is relatively low. Our tried-and-tested power-boost feature has also increased by 10%\* to deliver an enhanced level of excavating performance and lifting power.

The versatility of the ZAXIS 350 may be evidenced by the attachment support system, with 11 modes that can be registered on the monitor for the easy fitment of different attachments. These two auxiliary spools are useful for attachments that require multiple, large volumes of oil flow.

Larger digging force allows efficient extraction of hard or compacted material.

\* Based upon typical work pattern collected via Global e-Service

## Key features

- 5% reduction in fuel consumption (PWR mode vs ZX-3 P-mode)\*
- 15% reduction in fuel consumption (ECO mode vs ZX-3 P-mode)\*
- New TRIAS hydraulic system higher productivity and less fuel consumption

- Attachment support system
- Power-boost
- Increased lifting capacity
- Larger swing power and digging force
- Two additional spools



# PRODUCTIVITY

The new ZAXIS 350 medium excavator has been designed with the environment in mind. Built to comply with the latest EU regulations on emissions standards, the machine helps to reduce your carbon footprint while still maintaining productivity on the job site. With a wide range of eco-friendly features, you can rely on the ZAXIS 350 to have a positive impact on efficiency while ensuring an immediate return on your initial investment.



# Striking a balance between powerful and sustainable efficiency



## Sustainable efficiency

We are dedicated to the sustainable development of the Hitachi product range, particularly for use on urban job sites. Therefore, the new ZAXIS 350 is a sign of our commitment to minimizing the impact of construction machinery on the environment in compliance with EU emission control Stage IIIB.

The ZAXIS 350 has been fitted with a muffler filter to capture air pollutants, which is automatically burnt thanks to an oxidation catalyst and exhaust temperature control. The variable geometry turbocharger and high volume-cooled EGR (Exhaust Gas Recirculation) also help to reduce nitrous oxide levels.

As well as reducing emissions, the ZAXIS 350's Auto Shut-down helps to prevent fuel wastage and lowers the level of noise in the cab.

In addition, all resin parts on the new ZAXIS medium excavator range are suitable for recycling and clearly marked for ease of use in this process.

## Powerful efficiency

We are also focusing on finding the right balance between people, planet and profit. So, we have assessed the total cost of ownership for the new ZAXIS 350 to ensure that your new machine contributes to the profitability of your business.

The powerful new-generation Stage IIIB-compliant engine in the ZAXIS 350 delivers higher productivity, with greater fuel efficiency and is fitted with state-of-the-art controls throughout all of the components. The TRIAS hydraulic system has also been developed to reach higher yields with better fuel consumption than the previous ZAXIS model.

Hitachi medium excavators are renowned for their powerful and reliable performance, especially when there are daily targets and ultimate deadlines to meet on busy job sites. The latest range of ZAXIS models have been designed for increased productivity without burdening the environment through sustainable operations.

## Key features

- Powerful and sustainable
- Stage IIIB-compliant engine
- Muffler filter that captures particulate matter
- Variable geometry turbocharger
- High volume-cooled EGR system
- TRIAS hydraulic system – fuel efficiency and higher productivity
- Environmentally friendly design
- Auto Shut-down – fuel saving for carbon dioxide reduction



# COMFORT

We believe that comfort and safety is the key to productivity. We consulted with our customers from all over the world to ensure that the ZAXIS 350 medium excavator exceeds the expectations of those who matter the most – the operators. The new model offers an all-round comfortable working environment, enhanced visibility and a wide range of user-friendly features to set it apart from the competition.





# Inside and out, the new ZAXIS medium excavators lead the way



## From the comfort of the cab

After a long shift on a road construction site or in the quarry, you need to feel ready to enjoy the rest of your day. Hitachi has taken the lead in operator comfort with the new ZAXIS 350, so that you can do just that.

The adjustable air-suspension seat features a new sliding mechanism with the capacity to be moved back further than ever before. The space underneath the monitor has also been expanded to allow for more leg room. The pressurized cab keeps dust and particles from entering.

## All-round visibility

Busy construction sites demand your full attention to avoid unnecessary damage or health and safety issues. The enhanced visibility – especially down the right-hand side of the new ZAXIS – will also save you time (and money), thanks to the latest innovations from Hitachi.

The repositioning of the monitor and door enhances your view, as well as making access to and from the cab much easier. The latest rear-view camera offers a closer view of the counterweight to reduce the blind spot.

## User-friendly functionality

Hitachi has invested heavily in the advanced technology inherent within the new ZAXIS. The power remains firmly at your fingertips thanks to the functionality of the colour monitor and ergonomic controls.

The new multi-function LCD monitor has a large seven-inch screen that is easy to view. It provides a wide range of useful technical information, including a clear indication of the machine's status and settings with multi-lingual support in up to 32 languages. The monitor and ergonomically designed switches have been grouped together within easy reach of your right hand. The proportional switch in the new, optional, auxiliary function lever allows easy control of the front attachment.

## Enjoy your work

Time flies when you're having fun, but we also realise that a happy operator is also a more productive one. That's why we have renewed our focus on providing a relaxed and enjoyable working environment within the cab.

The controls for the AM/FM stereo radio are now adjustable from the colour monitor. An auxiliary terminal has also been added to the sound system, so that you can work efficiently and smoothly to your favourite music via devices such as MP3 players and the inclusion of storage for an MP3 player.

## Key features

■ High-spec ROPS pressurised cab

■ Enhanced visibility

■ New colour LCD monitor

■ Easily accessible real-time information

■ Expansive leg room

■ Ergonomically designed control panel

■ Auxiliary terminal and storage for an MP3 player



# DURABILITY

Hitachi is regarded as a market leader in high-quality construction machinery. We have more than 40 years experience in the manufacture of mechanical and hydraulic equipment and our ZAXIS medium excavators, including the new ZAXIS 350, are designed to withstand some of the toughest working environments. Our advanced technological approach enables us to offer complete solutions to meet your requirements.



# Build to conquer tough working environments



## Durable parts

The new ZAXIS 350 has been designed to operate in the most challenging of working conditions. Tough job sites require reliable machines, which deliver increased levels of availability and productivity. The bottom line is that you will enjoy a lower cost of ownership thanks to the durability of our medium excavators.

The strengthened boom end and foot on each new ZAXIS 350 are good examples. The brackets on the boom end and foot have been equipped with bushings to enhance their durable characteristics and withstand the rigours of long hours in rugged environments.

A filter-type high-performance water separator is provided standard. It captures moisture in fuel, even from fuel which contains a large amount of moisture.

## Reinforced undercarriage

The front idler and adjuster cylinder have been reinforced on the ZAXIS 350 for added durability. In addition, mud no longer sticks to the adjuster cylinder.

Reliability has been further addressed with increase in the welded section parts that comprise the X-beam. The travel motor brackets' upper and lower plates have been extended, which has delivered a 40% reduction in stress.

## ROPS-compliant cab

The pressurised and ROPS-compliant CRES V (Center pillar reinforced structure) cab prevents the penetration of dust and protects you from the potential risks of the job site. The Roll-over Protective Structure (ROPS) is designed to protect the operator in the unlikely event of the machine tipping or rolling over.

## Key features

- Proven Hitachi quality
- More than 40 years of expertise
- Strengthened front attachment
- Reinforced undercarriage



# MAINTENANCE

Hitachi construction machinery is renowned for its quality and reliability and is often operated in the most remote and toughest job sites around the world. Wherever you use your ZAXIS 350 medium excavator, you can be assured of the highest levels of availability, regardless of location, as well as a range of easily accessible features for routine cleaning and maintenance.

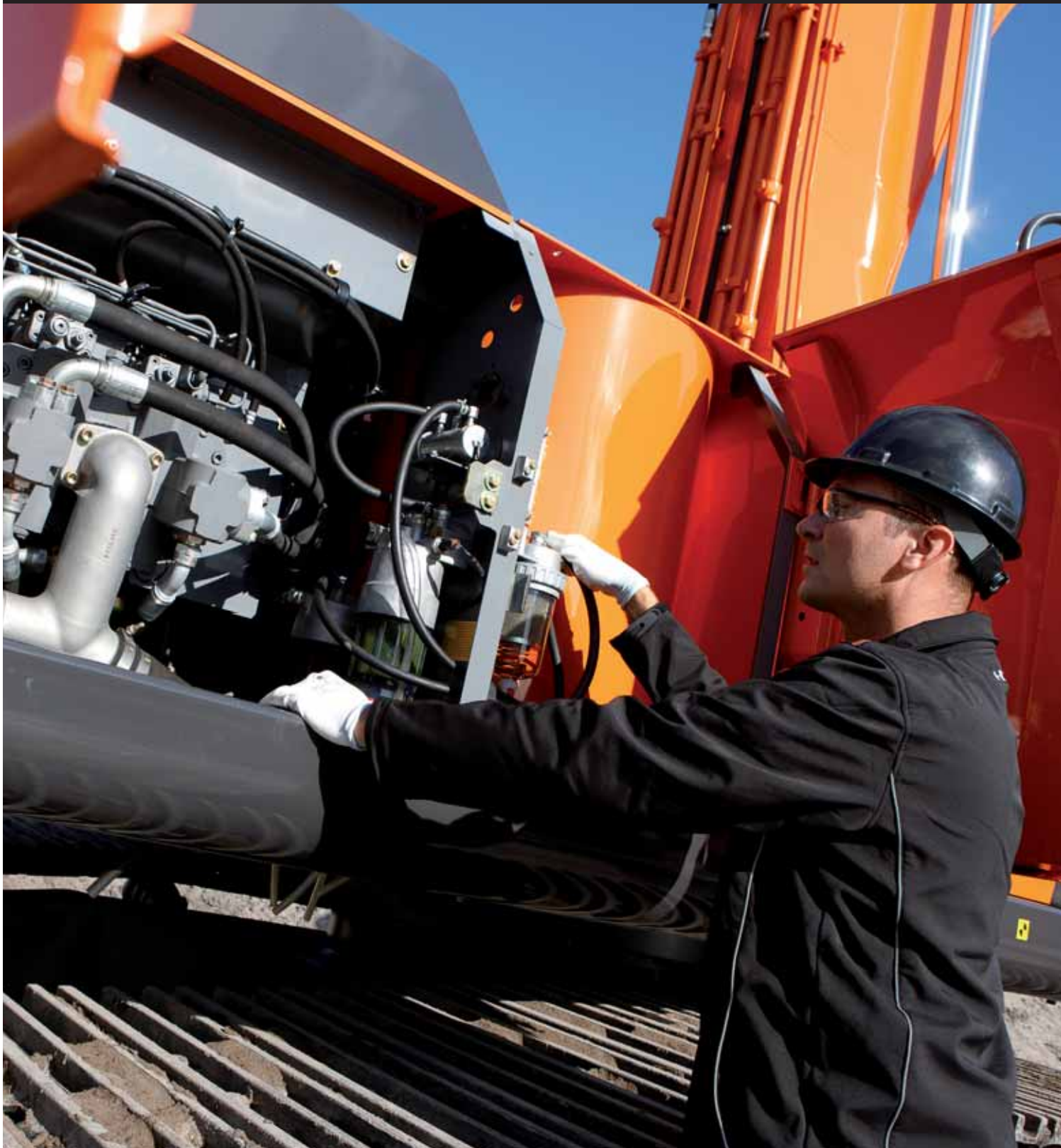

# Keep working for longer thanks to user-friendly accessible features



## Easy access

We have made life easier for you by introducing a range of convenient features integrated within the new ZAXIS range of medium excavators. Our engineers have assessed your requirements and integrated a number of time-saving factors for routine maintenance.

Using the technology within the multi-function LCD monitor you can check engine oil volumes and see the warning light that appears when the hydraulic oil and fuel filters are due for replacement. In addition, you can set the routine service schedule to help prevent breakdowns each time the ignition switch is turned on.

On the exterior of the ZAXIS 350, the air conditioning condenser can be easily opened for cleaning the condenser and radiator. Severe blockages can also be cleared by blowing air through the convenient one-touch openable upper cover above the radiator.

From ground level, you can replace the fuel filters, engine oil filter and air cleaner, and other work is aided by non-slip steps for easy access to the upper structure of the machine.

## Easy cleaning

We believe that easy routine maintenance enhances the levels of productivity and availability for your machine. That's why we have designed the ZAXIS 350 with a series of convenient and quick solutions, so that you can enjoy long, trouble-free days on the job site.

The interior anti-dust filter is a good example of these initiatives. It has been placed on the outside of the air conditioning condenser and fuel cooler. The oil cooler has been placed separately.

---

## Key features

- Global e-Service monitors muffler filter
- Daily checks from ground level
- Oil volumes checked from the operator's seat
- Quick and easy service access



# SUPPORT CHAIN

As soon as you become a Hitachi customer, you can rely on first-class after-sales service from your authorised dealer. Hitachi provides extensive support to each of the dealers within the Australian network, so that they can ensure your ZAXIS 350 continues to meet your requirements and exceed expectations. To further protect your investment in Hitachi construction machinery, we have introduced the Hitachi Support Chain after-sales programme. This gives you the flexibility to create a tailor-made service plan from the following key-areas, "links" in the chain of service available from Hitachi via your local dealer.



# A flexible after-sales programme created to protect your investment

## Global e-Service

The new ZAXIS excavator is equipped with a GPRS communication system\*. This sends a wide range of machine data to the Hitachi main server. Via the Global e-Service database, you will have remote access to all of this data. All you need is an internet connection and your Global e-Service log-in details.

Global e-Service enables you and your dealer to download and share this data, helping you to remotely manage your fleet. The online facility also helps your dealer to proactively advise you on preventive maintenance and related special offers.

The latest information on the ZAXIS excavator is available 24/7 and includes operational data, such as the number of working hours, fuel consumption figures, working modes and location. This helps you to reduce running costs, plan jobs efficiently and keep up to date with machine maintenance – to ensure optimum performance and minimal downtime.

## Technical support

The professional and highly trained Hitachi service team combines the global expertise and knowledge of Hitachi Construction Machinery with your local language and culture. We take a proactive approach towards customer service by continuously training our dealer personnel, so that the available global knowledge is passed on to each individual technician in our dealer network.

## Extended warranty and service contracts

Every new Hitachi model is covered by a full manufacturer's warranty. However, your ZAXIS excavator may require extra protection due to severe working conditions or to reduce equipment repair costs. To meet these demands, our dealers offer the option of a unique extended warranty programme (HELP – Hitachi Extended Life Program) and comprehensive service contracts – the most effective way to optimise the performance of your new ZAXIS excavator.

## Parts and remanufactured components

Hitachi offers different lines of parts and components to suit your specific needs. In addition to our range of genuine parts, there are other options available:

- If your machines have been working for several years, Hitachi can offer a second line of genuine parts as an attractively priced solution.
- For that highly demanding application or climate, Hitachi provides a line of parts with extra performance.
- When you are looking for an economical solution for preventive replacements, remanufactured components are the best option.

Whatever choice you make, you can be assured of the renowned Hitachi quality and warranty to give you added peace of mind.

Your Hitachi dealer can supply you with more details on each of the above parts lines.



\* The GPRS communication system is standard equipment for new ZAXIS excavators, however, the availability of the communication system depends on licensing regulations in your country. Please contact your Hitachi dealer for more information or to apply for a Global e-Service account.

## Key features

- Check each of your machines from your office – 24/7
- Have a remote insight into fuel consumption
- Check the current and previous locations and movements of your machine(s)

- See maintenance status and items due for renewal on each of your machines
- Receive e-mail notifications for any machine alerts, unexpected movements and so on

# SPECIFICATIONS

## ENGINE

Model .....	Isuzu AL-6HK1X
Type .....	4-cycle water-cooled, common rail direct injection
Aspiration .....	Variable geometry turbocharged, intercooled, cooled EGR
After treatment .....	Muffler filter
No. of cylinders .....	6
Rated power	
ISO 14396 .....	210 kW at 1 900 min <sup>-1</sup>
ISO 9249, net .....	202 kW at 1 900 min <sup>-1</sup>
EEC 80/1269, net .....	202 kW at 1 900 min <sup>-1</sup>
SAE J1349, net .....	202 kW at 1 900 min <sup>-1</sup>
Maximum torque .....	1 080 Nm at 1 500 min <sup>-1</sup>
Piston displacement .....	7.790 L
Bore and stroke .....	115 mm x 125 mm
Batteries .....	2 x 12 V / 128 Ah

## HYDRAULIC SYSTEM

### Hydraulic Pumps

Main pumps .....	3 variable displacement axial piston pumps
Maximum oil flow .....	2 x 288 L/min 1 x 260 L/min
Pilot pump .....	1 gear pump
Maximum oil flow .....	36.4 L/min

### Hydraulic Motors

Travel .....	2 variable displacement axial piston motors
Swing .....	1 swash plate piston motor

### Relief Valve Settings

Implement circuit .....	34.3 MPa
Swing circuit .....	32.4 MPa
Travel circuit .....	34.3 MPa
Pilot circuit .....	3.90 MPa
Power boost .....	38.0 MPa

### Hydraulic Cylinders

	Quantity	Bore	Rod diameter
Boom	2	145 mm	100 mm
Arm	1	170 mm	115 mm
Bucket	1	140 mm	95 mm

## UPPERSTRUCTURE

### Revolving Frame

D-section frame for resistance to deformation.

### Swing Device

Axial piston motor with planetary reduction gear is bathed in oil. Swing circle is single-row. Swing parking brake is spring-set/hydraulic-released disc type.

Swing speed .....	9.7 min <sup>-1</sup>
Swing torque .....	120 kNm

### Operator's Cab

Independent spacious cab, 1 005 mm wide by 1 675 mm high, conforming to ISO\* Standards.

\* International Organization for Standardization

## UNDERCARRIAGE

### Tracks

Heat-treated connecting pins with dirt seals. Hydraulic (grease) track adjusters with shock-absorbing recoil springs.

### Numbers of Rollers and Shoes on Each Side

Upper rollers .....	2
Lower rollers .....	7 : ZX350-5B / ZX350H-5B 8 : ZX360LC-5B / ZX360LCH-5B
Track shoes .....	45 : ZX350-5B / ZX350H-5B 48 : ZX360LC-5B / ZX360LCH-5B
Track guards .....	3

### Travel Device

Each track driven by 2-speed axial piston motor. Parking brake is spring-set/hydraulic-released disc type. Automatic transmission system: High-Low.

Travel speeds .....	High : 0 to 5.0 km/h Low : 0 to 3.2 km/h
---------------------	---

Maximum traction force ... 298 kN

Gradeability .....

70% (35 degree) continuous
----------------------------

## SOUND LEVEL

Sound level in cab according to ISO 6396 .....	LpA 70 dB(A)
External sound level according to ISO 6395 and EU Directive 2000/14/EC .....	LwA 104 dB(A)

## SERVICE REFILL CAPACITIES

Fuel tank .....	630 L
Engine coolant .....	40.0 L
Engine oil .....	48.0 L
Swing device .....	15.7 L
Travel device (each side) .....	9.20 L
Hydraulic system .....	340 L
Hydraulic oil tank .....	180 L



## WEIGHTS AND GROUND PRESSURE

### Operating Weight and Ground Pressure

			ZAXIS 350		ZAXIS 360LC		ZAXIS 350H		ZAXIS 360LCH	
Shoe type	Shoe width	Arm length	kg	kPa	kg	kPa	kg	kPa	kg	kPa
Triple grouser	600 mm	2.67 m	32 600	66	33 300	63	–	–	–	–
		3.20 m	32 700	66	33 400	63	34 600*	70	35 300*	66
		4.00 m	32 800	67	33 500	63	–	–	–	–
	700 mm	2.67 m	33 200	58	33 900	54	–	–	–	–
		3.20 m	33 300	58	34 000	55	35 000	61	35 700	57
		4.00 m	33 400	58	34 100	55	–	–	–	–
	800 mm	2.67 m	33 600	51	34 300	48	–	–	–	–
		3.20 m	33 600	51	34 400	48	35 400	54	36 100	57
		4.00 m	33 800	51	34 500	48	–	–	–	–

Including 1.40 m<sup>3</sup> (ISO heaped), bucket weight and counterweight.

\*Reinforced shoes

### Basic Machine Weight and Overall Width

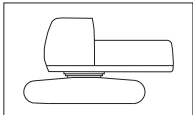

Excluding front end attachment, fuel, hydraulic oil and coolant etc. Including counterweight.

#### ZAXIS 350

Shoe width	Weight	Overall width
600 mm	24 900 kg	3 190 mm
700 mm	25 500 kg	3 290 mm
800 mm	25 900 kg	3 390 mm

#### ZAXIS 360LC

Shoe width	Weight	Overall width
600 mm	25 500 kg	3 190 mm
700 mm	26 100 kg	3 290 mm
800 mm	26 500 kg	3 390 mm

#### ZAXIS 350H

Shoe width	Weight	Overall width
600 mm*	26 400 kg	3 190 mm
700 mm	26 800 kg	3 290 mm
800 mm	27 200 kg	3 390 mm

#### ZAXIS 360LCH

Shoe width	Weight	Overall width
600 mm*	27 100 kg	3 190 mm
700 mm	27 500 kg	3 290 mm
800 mm	27 900 kg	3 390 mm

\*Reinforced shoes

### Components Weight

	ZAXIS 350 / ZAXIS 360LC	ZAXIS 350H / ZAXIS 360LCH
Counterweight	6 900 kg	7 600 kg
6.40 m boom (with arm cylinder and boom cylinder)	3 870 kg	3 870 kg
2.67 m arm (with bucket cylinder)	1 520 kg	–
3.20 m arm (with bucket cylinder)	1 600 kg	1 820 kg
4.00 m arm (with bucket cylinder)	1 770 kg	–
1.40 m <sup>3</sup> bucket	1 170 kg	1 330 kg

## BUCKET AND ARM DIGGING FORCE

Arm length	ZAXIS 350 / ZAXIS 360LC			ZAXIS 350H / ZAXIS 360LCH
	2.67 m	3.20 m	4.00 m	3.20 m
Bucket digging force* ISO	246 kN			246 kN
Bucket digging force* SAE	214 kN			214 kN
Arm crowd force* ISO	222 kN	185 kN	158 kN	185 kN
Arm crowd force* SAE	213 kN	177 kN	154 kN	177 kN

\* At power boost

# SPECIFICATIONS

## BACKHOE ATTACHMENTS

Boom and arms are of welded, box-section design. 6.40 m boom, and 2.67 m, 3.20 m and 4.00 m arms are available. Bucket is of welded steel structure. Side clearance adjust mechanism provided on the bucket joint bracket.

### Buckets

Capacity	Width		No. of teeth	Weight	Recommendation							
					ZAXIS 350			ZAXIS 360LC			ZAXIS 350H	ZAXIS 360LCH
	Without side cutters	With side cutters			Arm 2.67 m	Arm 3.20 m	Arm 4.00 m	Arm 2.67 m	Arm 3.20 m	Arm 4.00 m	Arm 3.20 m H	Arm 3.20 m H
1.15 m <sup>3</sup>	1 100 mm	1 230 mm	5	1 080 kg	⊙	⊙	⊙	⊙	⊙	⊙	—	—
1.40 m <sup>3</sup>	1 280 mm	1 410 mm	5	1 170 kg	⊙	⊙	○	⊙	⊙	⊙	—	—
1.62 m <sup>3</sup>	1 460 mm	1 590 mm	5	1 260 kg	○	○	—	○	○	□	—	—
1.86 m <sup>3</sup>	1 640 mm	—	5	1 220 kg	□	—	—	□	—	—	—	—
*1,2 1.38 m <sup>3</sup>	—	1 360 mm	5	1 340 kg	⊙	⊙	—	⊙	⊙	—	●	●
*1,2 1.50 m <sup>3</sup>	—	1 470 mm	5	1 400 kg	○	○	—	○	○	—	⊙	●

\*1 Super V teeth type bucket

\*2 Rock bucket

⊙ Suitable for materials with density of 2 000 kg/m<sup>3</sup> or less

○ Suitable for materials with density of 1 600 kg/m<sup>3</sup> or less

□ Suitable for materials with density of 1 100 kg/m<sup>3</sup> or less

● Heavy-duty service

— Not applicable

## WORKING RANGES

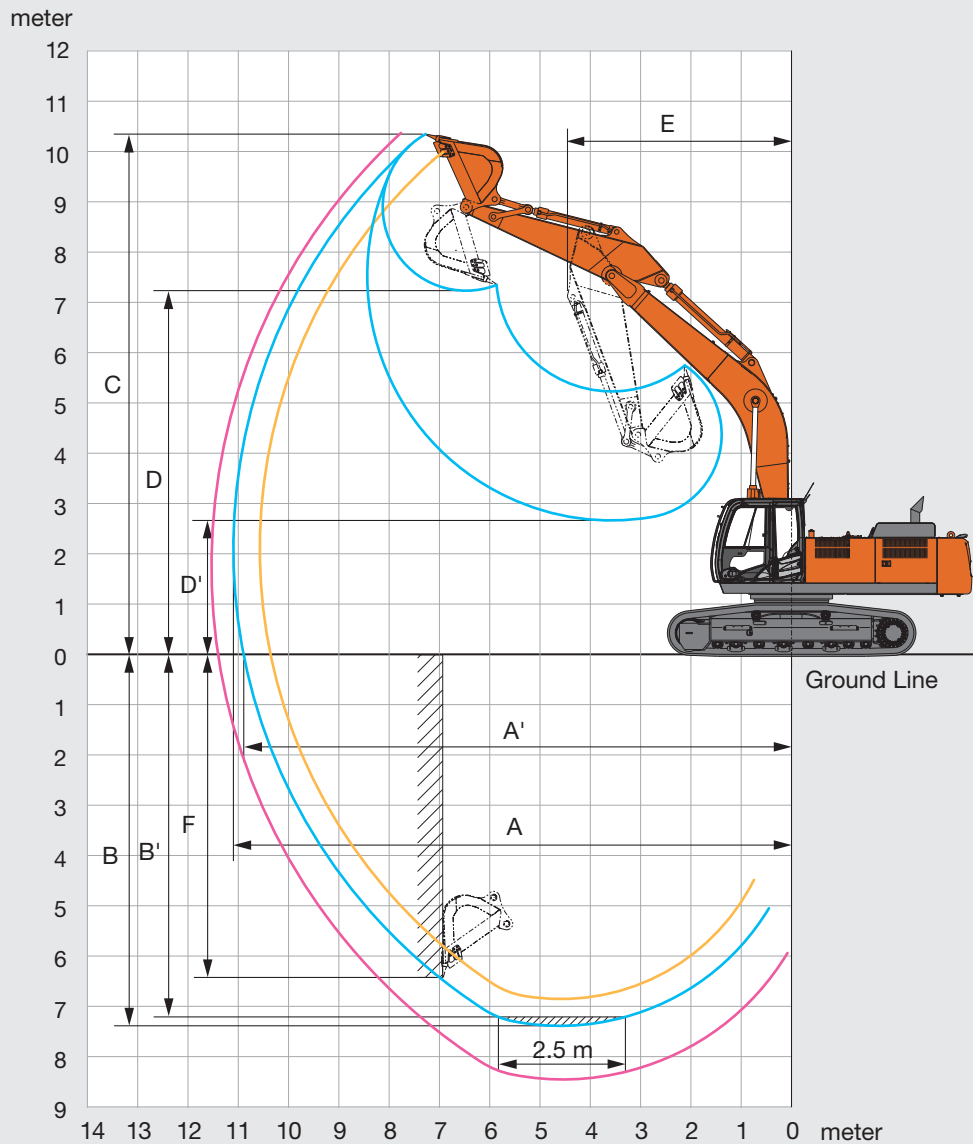

The illustration is shown ZAXIS 360LC

Unit: mm

Arm length	ZAXIS 350 / ZAXIS 360LC			ZAXIS 350H / ZAXIS 360LCH
	2.67 m	3.20 m	4.00 m	3.20 m
A Max. digging reach	10 570	11 100	11 860	11 100
A' Max. digging reach (on ground)	10 360	10 890	11 670	10 890
B Max. digging depth	6 840	7 380	8 180	7 380
B' Max. digging depth for 2.5 m level	6 640	7 210	8 040	7 210
C Max. cutting height	9 990	10 360	10 750	10 360
D Max. dumping height	6 940	7 240	7 630	7 240
D' Min. dumping height	3 210	2 680	1 880	2 680
E Min. swing radius	4 610	4 460	4 470	4 460
F Max. vertical wall digging depth	5 510	6 420	7 270	6 420

Excluding track shoe lug

# SPECIFICATIONS

## DIMENSIONS

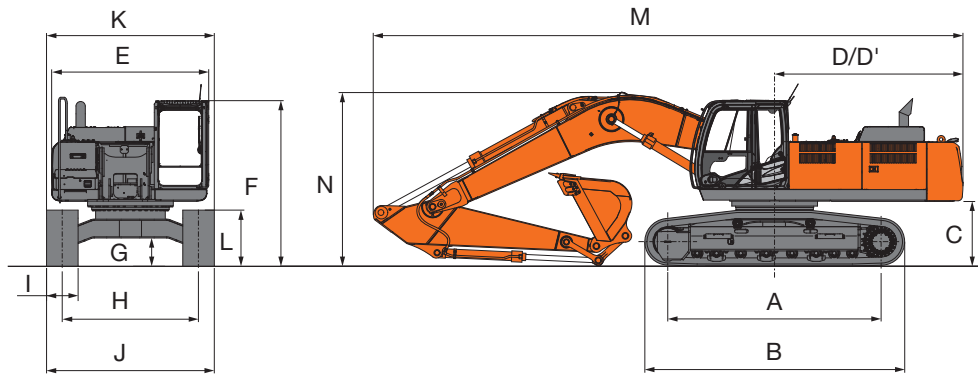

The illustration is shown ZAXIS 360LC

Unit: mm

	ZAXIS 350	ZAXIS 360LC	ZAXIS 350H	ZAXIS 360 LCH
A Distance between tumbler	3 730	4 050	3 730	4 050
B Undercarriage length	4 640	4 950	4 640	4 950
* C Counterweight clearance		1 160		1 160
D Rear-end swing radius		3 600		3 600
D' Rear-end length		3 590		3 590
E Overall width of upperstructure		2 990		2 990
F Overall height of cab		3 150		3 150
* G Min. ground clearance		500		500
H Track gauge		2 590		2 590
I Track shoe width		G 600		G 600
J Undercarriage width		3 190		3 190
K Overall width		3 190		3 190
* L Track height with triple grouser shoes		1 070		1 070
M Overall length				
With 2.67 m arm		11 350		–
With 3.20 m arm		11 220		11 220
With 4.00 m arm		11 310		–
N Overall height of boom				
With 2.67 m arm		3 470		–
With 3.20 m arm		3 270		3 270
With 4.00 m arm		3 600		–

\* Excluding track shoe lug      G: Triple grouser shoe

# LIFTING CAPACITIES

- Notes: 1. Ratings are based on ISO 10567.  
 2. Lifting capacity does not exceed 75% of tipping load with the machine on firm, level ground or 87% full hydraulic capacity.  
 3. The load point is the center-line of the bucket pivot mounting pin on the arm.  
 4. \*Indicates load limited by hydraulic capacity.  
 5. 0 m = Ground.

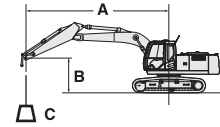

A: Load radius  
 B: Load point height  
 C: Lifting capacity

For lifting capacities, subtract bucket and quick hitch weight from lifting capacities.

## ZAXIS 350

Rating over-front Rating over-side or 360 degrees Unit : kg

Conditions	Load point height m	Load radius												At max. reach		
		1.5		3.0		4.5		6.0		7.5		9.0		meter		
Boom 6.40 m	6.0							*10 430	9 730	9 460	6 800			8 480	6 090	8.00
Arm 2.67 m	4.5					*15 030	14 260	*11 780	9 260	9 240	6 610			7 450	5 330	8.58
Counterweight 6 900 kg	3.0					*18 500	12 990	12 540	8 710	8 960	6 340			6 950	4 940	8.87
Shoe 600 mm	1.5							12 050	8 270	8 700	6 100			6 800	4 810	8.89
	0 (Ground)					18 640	12 030	11 770	8 020	8 530	5 940			6 990	4 920	8.65
	-1.5			*13 900	*13 900	18 670	12 060	11 700	7 950	8 490	5 910			7 620	5 340	8.13
	-3.0			*22 390	*22 390	*17 380	12 260	11 820	8 060					9 020	6 300	7.26
	-4.5			*17 050	*17 050	*13 510	12 680							*10 040	8 660	5.88
Boom 6.40 m	6.0									*9 020	6 910			*6 310	5 480	8.58
Arm 3.20 m	4.5							*11 010	9 420	9 330	6 690	6 950	4 970	*6 340	4 850	9.12
Counterweight 6 900 kg	3.0					*17 250	13 380	12 700	8 850	9 020	6 400	6 820	4 850	6 370	4 520	9.39
Shoe 600 mm	1.5					19 140	12 450	12 150	8 350	8 730	6 130	6 680	4 710	6 240	4 410	9.42
	0 (Ground)					18 670	12 050	11 800	8 030	8 510	5 930	6 580	4 620	6 390	4 490	9.19
	-1.5			*13 330	*13 330	18 590	11 980	11 650	7 910	8 420	5 840			6 870	4 820	8.70
	-3.0	*15 640	*15 640	*21 080	*21 080	*18 380	12 110	11 700	7 950	8 480	5 900			7 930	5 540	7.90
	-4.5			*20 080	*20 080	*15 230	12 440	*11 480	8 200					*9 770	7 160	6.66
Boom 6.40 m	7.5													*5 040	*5 040	8.63
Arm 4.00 m	6.0									*8 010	7 060	*6 810	5 160	*4 890	4 740	9.41
Counterweight 6 900 kg	4.5									*8 760	6 810	7 040	5 050	*4 890	4 250	9.91
Shoe 600 mm	3.0					*15 200	13 930	*11 580	9 060	9 120	6 480	6 860	4 880	*5 040	3 990	10.2
	1.5					*18 400	12 760	12 300	8 470	8 780	6 160	6 670	4 700	*5 330	3 880	10.2
	0 (Ground)			*8 070	*8 070	18 740	12 090	11 820	8 050	8 500	5 900	6 520	4 560	5 620	3 930	9.97
	-1.5	*8 120	*8 120	*12 230	*12 230	18 440	11 840	11 570	7 820	8 330	5 750	6 440	4 490	5 960	4 160	9.53
	-3.0	*12 720	*12 720	*17 660	*17 660	18 450	11 850	11 520	7 770	8 300	5 720			6 680	4 660	8.80
	-4.5	*18 220	*18 220	*23 770	*23 770	*17 120	12 070	11 660	7 900	8 460	5 870			8 160	5 680	7.71
	-6.0			*17 180	*17 180	*12 750	12 560	*8 950	8 320					*8 780	8 210	6.06



## ZAXIS 360LC













Rating over-front Rating over-side or 360 degrees Unit : kg

Conditions	Load point height m	Load radius												At max. reach		
		1.5		3.0		4.5		6.0		7.5		9.0		meter		
Boom 6.40 m	6.0							*10 430	9 870	*9 690	6 910			9 540	6 190	8.00
Arm 2.67 m	4.5					*15 030	14 460	*11 780	9 400	*10 210	6 710			8 390	5 420	8.58
Counterweight 6 900 kg	3.0					*18 500	13 190	*13 360	8 850	10 130	6 450			7 840	5 020	8.87
Shoe 600 mm	1.5							13 790	8 400	9 860	6 210			7 690	4 890	8.89
	0 (Ground)					*20 300	12 240	13 500	8 150	9 690	6 050			7 920	5 010	8.65
	-1.5			*13 900	*13 900	*19 460	12 260	13 430	8 090	9 650	6 010			8 640	5 440	8.13
	-3.0			*22 390	*22 390	*17 380	12 460	*13 420	8 200					10 260	6 410	7.26
	-4.5			*17 050	*17 050	*13 510	12 890							*10 040	8 810	5.88
Boom 6.40 m	6.0									*9 020	7 010			*6 310	5 560	8.58
Arm 3.20 m	4.5							*11 010	9 560	*9 660	6 790	*7 470	5 050	*6 340	4 930	9.12
Counterweight 6 900 kg	3.0					*17 250	13 590	*12 710	8 990	10 200	6 500	7 690	4 930	*6 560	4 600	9.39
Shoe 600 mm	1.5					*19 780	12 650	13 900	8 490	9 900	6 230	7 550	4 800	*7 010	4 490	9.42
	0 (Ground)					*20 550	12 260	13 530	8 170	9 680	6 030	7 450	4 710	7 230	4 570	9.19
	-1.5			*13 330	*13 330	*20 010	12 180	13 380	8 040	9 580	5 950			7 790	4 910	8.70
	-3.0	*15 640	*15 640	*21 080	*21 080	*18 380	12 310	13 430	8 090	9 650	6 010			8 990	5 640	7.90
	-4.5			*20 080	*20 080	*15 230	12 650	*11 480	8 330					*9 770	7 280	6.66
Boom 6.40 m	7.5													*5 040	*5 040	8.63
Arm 4.00 m	6.0									*8 010	7 170	*6 810	5 240	*4 890	4 820	9.41
Counterweight 6 900 kg	4.5									*8 760	6 910	7 920	5 130	*4 890	4 330	9.91
Shoe 600 mm	3.0					*15 200	14 130	*11 580	9 190	*9 750	6 590	7 740	4 960	*5 040	4 060	10.2
	1.5					*18 400	12 960	*13 300	8 610	9 950	6 270	7 550	4 790	*5 330	3 960	10.2
	0 (Ground)			*8 070	*8 070	*20 080	12 290	13 570	8 180	9 660	6 010	7 390	4 640	*5 810	4 010	9.97
	-1.5	*8 120	*8 120	*12 230	*12 230	*20 310	12 040	13 300	7 960	9 490	5 860	7 310	4 570	*6 600	4 240	9.53
	-3.0	*12 720	*12 720	*17 660	*17 660	*19 370	12 050	13 250	7 910	9 460	5 830			7 580	4 750	8.80
	-4.5	*18 220	*18 220	*23 770	*23 770	*17 120	12 270	*12 960	8 040	9 620	5 970			*9 180	5 780	7.71
	-6.0			*17 180	*17 180	*12 750	12 750	*8 950	8 450					*8 780	8 350	6.06



# LIFTING CAPACITIES













## ZAXIS 350H

 Rating over-front  Rating over-side or 360 degrees Unit : kg

Conditions	Load point height m	Load radius												At max. reach		
		1.5		3.0		4.5		6.0		7.5		9.0		meter		
																
Boom 6.40 m	9.0															
Arm 3.20 m	7.5															
Counterweight 7 600 kg	6.0									*8 850	7 330			*6 220	5 810	8.58
Shoe 600 mm	4.5							*10 830	10 010	*9 480	7 100	7 350	5 270	*6 250	5 150	9.12
	3.0					*17 000	14 240	*12 500	9 410	9 550	6 800	7 210	5 140	*6 470	4 800	9.39
	1.5					*19 490	13 270	12 880	8 890	9 250	6 510	7 070	5 010	6 610	4 680	9.42
	0 (Ground)					19 850	12 860	12 520	8 560	9 020	6 310	6 960	4 910	6 760	4 770	9.19
	-1.5			*13 250	*13 250	*19 720	12 790	12 370	8 430	8 930	6 220			7 280	5 120	8.70
	-3.0	*15 560	*15 560	*21 010	*21 010	*18 090	12 940	12 430	8 480	9 000	6 280			8 410	5 900	7.90
	-4.5			*19 740	*19 740	*14 960	13 290	*11 260	8 740					*9 560	7 640	6.66
	-6.0															

## ZAXIS 360LCH

 Rating over-front  Rating over-side or 360 degrees Unit : kg

Conditions	Load point height m	Load radius												At max. reach		
		1.5		3.0		4.5		6.0		7.5		9.0		meter		
																
Boom 6.40 m	9.0															
Arm 3.20 m	7.5															
Counterweight 7 600 kg	6.0									*8 850	7 450			*6 220	5 910	8.58
Shoe 600 mm	4.5							*10 830	10 160	*9 480	7 210	*7 380	5 360	*6 250	5 240	9.12
	3.0					*17 000	14 470	*12 500	9 560	*10 330	6 910	8 150	5 240	*6 470	4 890	9.39
	1.5					*19 490	13 500	*13 940	9 040	10 490	6 630	7 990	5 100	*6 920	4 770	9.42
	0 (Ground)					*20 250	13 090	14 370	8 710	10 270	6 420	7 890	5 000	7 660	4 860	9.19
	-1.5			*13 250	*13 250	*19 720	13 020	14 220	8 580	10 170	6 340			8 260	5 220	8.70
	-3.0	*15 560	*15 560	*21 010	*21 010	*18 090	13 170	*13 770	8 630	10 240	6 400			9 550	6 010	7.90
	-4.5			*19 740	*19 740	*14 960	13 520	*11 260	8 900					*9 560	7 770	6.66
	-6.0															

# EQUIPMENT

● : Standard equipment

○ : Optional equipment

ENGINE	ZAXIS 350 / ZAXIS 360LC	ZAXIS 350H / ZAXIS 360LCH
Air cleaner double filters	●	●
Alternator 50 A	●	●
Auto idle system	●	●
Auto shut-down control	●	●
Cartridge-type engine oil filter	●	●
Fuel main filter	●	●
Fuel pre-filter	●	●
Dust-proof indoor net	●	●
Dry-type air filter with evacuator valve (with air filter restriction indicator)	●	●
ECO/PWR mode control	●	●
Electrical fuel feed pump	●	●
Engine oil drain coupler	●	●
Engine warm-up device	●	●
Fan guard	●	●
Fuel cooler	●	●
High performance water separator	●	●
Isolation-mounted engine	●	●
Maintenance free pre-cleaner	●	●
Muffler filter	●	●
Radiator, oil cooler and intercooler	●	●
Radiator reserve tank	●	●

HYDRAULIC SYSTEM		
Auto power lift	●	●
Control valve with main relief valve	●	●
Full-flow filter	●	●
High mesh full flow filter with restriction indicator	○	○
Hose rupture valve for arm	●	●
Hose rupture valve for boom	●	●
Pilot filter	●	●
Power boost	●	●
Suction filter	●	●
Swing dampener valve	●	●
Two extra port for control valve	●	●
Variable relief valve for breaker & crusher	●	●
Work mode selector	●	●

CAB	ZAXIS 350 / ZAXIS 360LC	ZAXIS 350H / ZAXIS 360LCH
All-weather sound suppressed steel cab	●	●
AM-FM radio	●	●
Ashtray	●	●
Auto control air conditioner	●	●
Auxiliary function lever (breaker or assist)	○	○
AUX. terminal and storage	●	●
Cigarette lighter 24 V	●	●
CRES V (center pillar reinforced structure) cab	●	●
Drink holder with hot & cool function	●	●
Electric double horn	●	●
Engine shut-off switch	●	●
Equipped with reinforced, tinted (green colour) glass windows	●	●
Evacuation hammer	●	●
Fire extinguisher bracket	○	○
Floor mat	●	●
Footrest	●	●
Front guard (lower mesh type)	○	●
Front guard (upper mesh type)	○	—
Front window washer	●	●
Glove compartment	●	●
Hot & cool box	●	●
Intermittent windshield wipers	●	●
Key cylinder light	●	●
Laminated round glass window	●	●
LED room light with door courtesy	●	●
Mesh guard (cab top)	○	—
OPG front guard Level II (ISO10262) compliant cab	○	○
OPG top guard Level II (ISO10262) compliant cab	○	●
Pilot control shut-off lever	●	●
Power outlet 12 V	●	●
Rear tray	●	●
Retractable seat belt	●	●
ROPS (ISO12117-2) compliant cab	●	●
Rubber radio antenna	●	●
Seat : air suspension seat with heater	●	●
Seat adjustment part : backrest, armrest, height and angle, slide forward / back	●	●
Short wrist control levers	●	●
Sun visor (front window/side window)	○	○
Transparent roof with slide curtain	●	●
Windows on front, upper, lower and left side can be opened	●	●
2 speakers	●	●
4 fluid-filled elastic mounts	●	●

Standard and optional equipment may vary by country, so please consult your Hitachi dealer for details.

# EQUIPMENT

MONITOR SYSTEM	ZAXIS 350 / ZAXIS 360LC	ZAXIS 350H / ZAXIS 360LCH
Alarm buzzers: overheat, engine oil pressure, overload	●	●
Alarms: overheat, engine warning, engine oil pressure, alternator, minimum fuel level, hydraulic filter restriction, air filter restriction, work mode, overload, etc	●	●
Display of meters: water temperature, hour, fuel rate, clock	●	●
Other displays: work mode, auto-idle, glow, rearview monitor, operating conditions, etc	●	●
32 languages selection	●	●

LIGHTS		
Additional boom light with cover	○	○
Additional cab roof front 2 lights	●	●
Additional cab roof rear 1 light	●	●
2 working lights	●	●

UPPER STRUCTURE		
Batteries 2 x 128 Ah	●	●
Counter weight 6 900 kg	●	—
Counterweight 7 600 kg	—	●
Electric fuel refilling pump with auto stop and filter	○	○
Fuel level float	●	●
Hydraulic oil level gauge	●	●
Rear view camera	●	●
Rear view mirror (right & left side)	●	●
Swing parking brake	●	●
Tool box	●	●
Undercover	●	—
Undercover 6.0 mm reinforced	○	●
Utility space	●	●

UNDERCARRIAGE		
Bolt-on sprocket	●	●
Reinforced track frame	—	●
Reinforced track links with pin seals	●	●
Shoe : 600 mm triple grouser	●	—
Shoe : 600 mm reinforced triple grouser	—	●
Track guard full track guards and hydraulic track adjuster	—	●
Track guard 3 track guards (each side) and hydraulic track adjuster	●	—
Travel motor covers	●	●
Travel parking brake	●	●
Track undercover	●	●
Upper and lower rollers	●	●
4 tie down brackets	●	●

FRONT ATTACHMENTS	ZAXIS 350 / ZAXIS 360LC	ZAXIS 350H / ZAXIS 360LCH
Arm (reinforced)	—	●
Arm (lower reinforced)	●	—
Boom (reinforced)	●	●
Casted bucket link A	●	●
Centralized lubrication system	●	●
Dirt seal on all bucket pins	●	●
Flanged pin	●	●
HN bushing	●	●
Reinforced link B	●	●
Reinforced resin thrust plate	●	●
WC (tungsten-carbide) thermal spraying	●	●
Accessories for 2 speed selector	○	●

ATTACHMENTS		
Additional pump (30 L/min)	○	○
Assist piping	○	○
Attachment basic piping	●	●
Breaker and crusher piping	●	●
Pilot accumulator	●	●

MISCELLANEOUS		
Battery disconnect switch	●	●
Global e-Service	●	●
Grease gun mechanical type	●	●
Grease gun electronic charging type	○	○
Level indicator	●	●
Lockable fuel refilling cap	●	●
Lockable machine covers	●	●
Onboard information controller	●	●
Satellite communication system unit	●	●
Skid-resistant tapes, plates and handrails	●	●
Standard tool kit	●	●
Swing alarm	○	○
Travel alarm	●	●
Travel direction mark on track frame	●	●
Theft prevention system*	○	○

Standard and optional equipment may vary by country, so please consult your Hitachi dealer for details.











**Built on the foundation of superb technological capabilities, Hitachi Construction Machinery is committed to providing leading-edge solutions and services to contribute as a reliable partner to the business of customers worldwide.**

---

## Hitachi Environmental Vision 2025

---

The Hitachi Group (the Group) released the Environmental Vision 2025 to reduce their annual carbon dioxide emissions. While the Group is committed to global production, the focus is to reduce the environmental impact of all products, and fulfil a sustainable society by tackling three goals — prevention of global warming, recycling of resources, and enhancing the ecosystem.

### **Reducing Environmental Impact by the New ZAXIS**

Hitachi reduces carbon emissions for global warming prevention according to LCA\*. The new ZAXIS exemplify the Group's commitment to the environment through features, such as the new standard mode which optimises fuel efficiency. Hitachi has long been committed to the recycling of components, such as aluminium parts in radiators and oil coolers. Resin parts are marked for recycling.

\*Life Cycle Assessment – ISO 14040

Prior to operating this machine, including the satellite communication system, in a country other than the country of its intended use, it may be necessary to make modifications to the machine to ensure it complies with the local regulatory standards (including safety standards) and legal requirements of that particular country. Please do not export or operate this machine outside the country of its intended use until such compliance has been confirmed. Please contact your Hitachi dealer regarding compliance. These specifications are subject to change without notice.

Illustrations and photos show the standard models, and may or may not include optional equipment, accessories, customer installed and modified parts, optional parts and all standard equipment with some differences in colour and features. Before use, read and understand the Operator's Manual for proper operation.

